

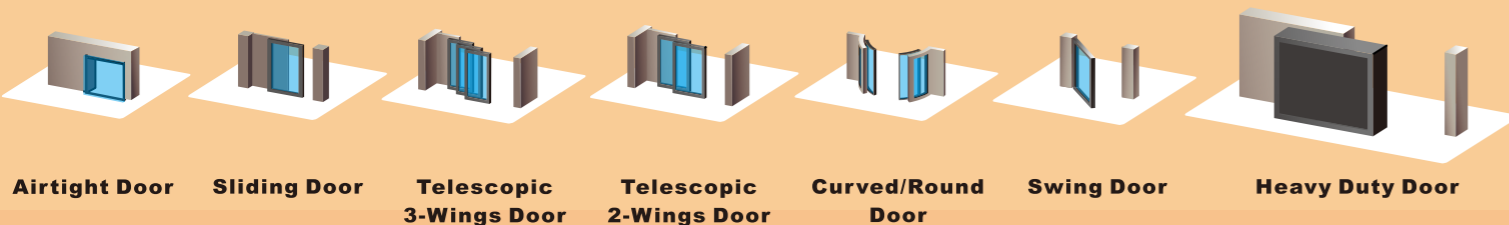

S-160 SUPER HEAVY DOOR *AUTOMATIC DOOR SYSTEM SERIES*



Airtight Door Sliding Door Telescopic 3-Wings Door Telescopic 2-Wings Door Curved/Round Door Swing Door Heavy Duty Door

 KING TA HAN TECHNOLOGY CO. LTD.
Location: Kaohsiung, Taiwan
Global Website: <http://www.kth-automaticdoor.com>
E-mail address: export@kthtw.com
kth@kthtw.com



KTH S-160 SUPER HEAVY DOOR

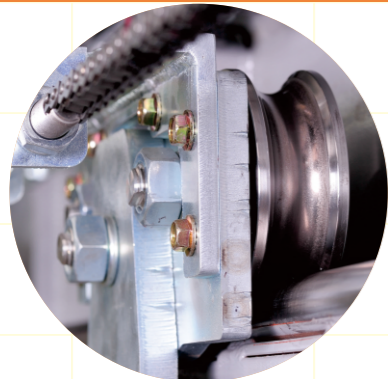

DURABLE HANGING TWIN WHEEL

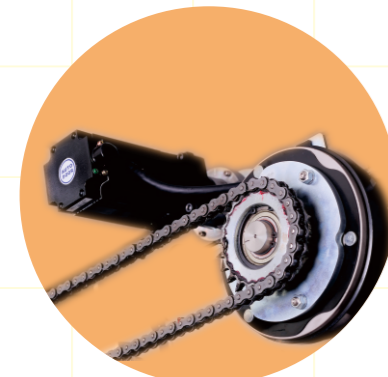

DC320V 370W BRUSHLESS DC MOTOR (PLANETARY GEAR)

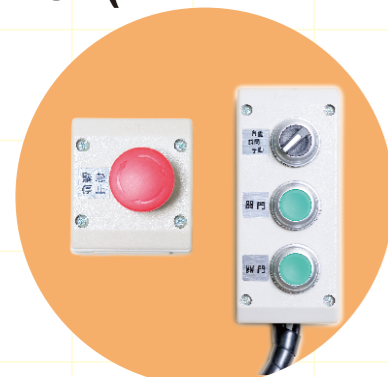

CONTROL SYSTEM



CONTROL SYSTEM

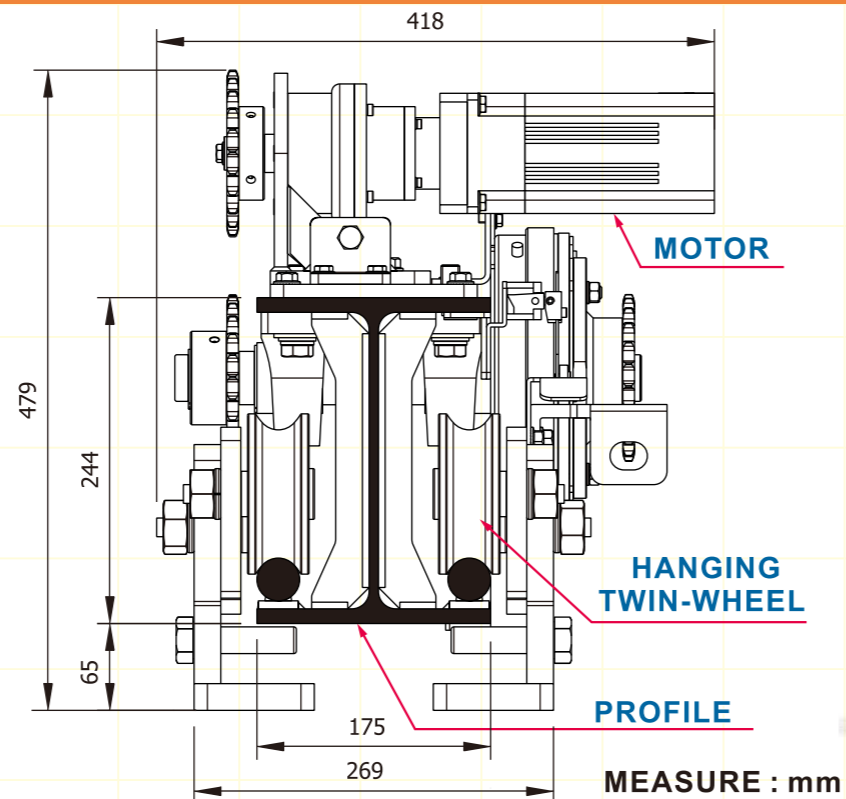

TYPE	S-160/S-161	
MODEL	SINGLE-WINGED	BI-PARTING
DOOR WEIGHT	10000kg X1 (DOOR)	8000kg X2 (DOOR)
DOOR WIDTH	1M~6M	1M~6M
PROFILE TYPE	H-TYPE STEEL/SINGLE TRACK	
MOTOR	DC320V 370W BRUSHLESS DC MOTOR (PLANETARY GEAR)	
TRANSMISSION DEVICE	ELECTROMAGNETIC BEARING-MOUNTED CLUTCH	
CONTROL	STANDARD MICRO-CONTROL	
POWER CONSUMPTION	370W	
VOLTAGE	AC220V	
ENVIRONMENTAL TEMPERATURE	-20℃~+50℃	
VOLUME	65 DECIBEL (MAX.)	
STARTING SPEED	230mm/SEC.	200mm/SEC.
STARTING TIMES	0~20 SEC. (REGULABLE)	
TRANSMISSION IMPORTANT CONDITION	ROLLER CHAIN 50-1R	
OPENING DOOR RANGE	FULL/HALF-OPEN (REGULABLE)	
MATERIAL of HANGER	STAINLESS 304	
BEARING	ROLLER BEARING	
SECOND SYSTEM	NONE/INCLUDING	

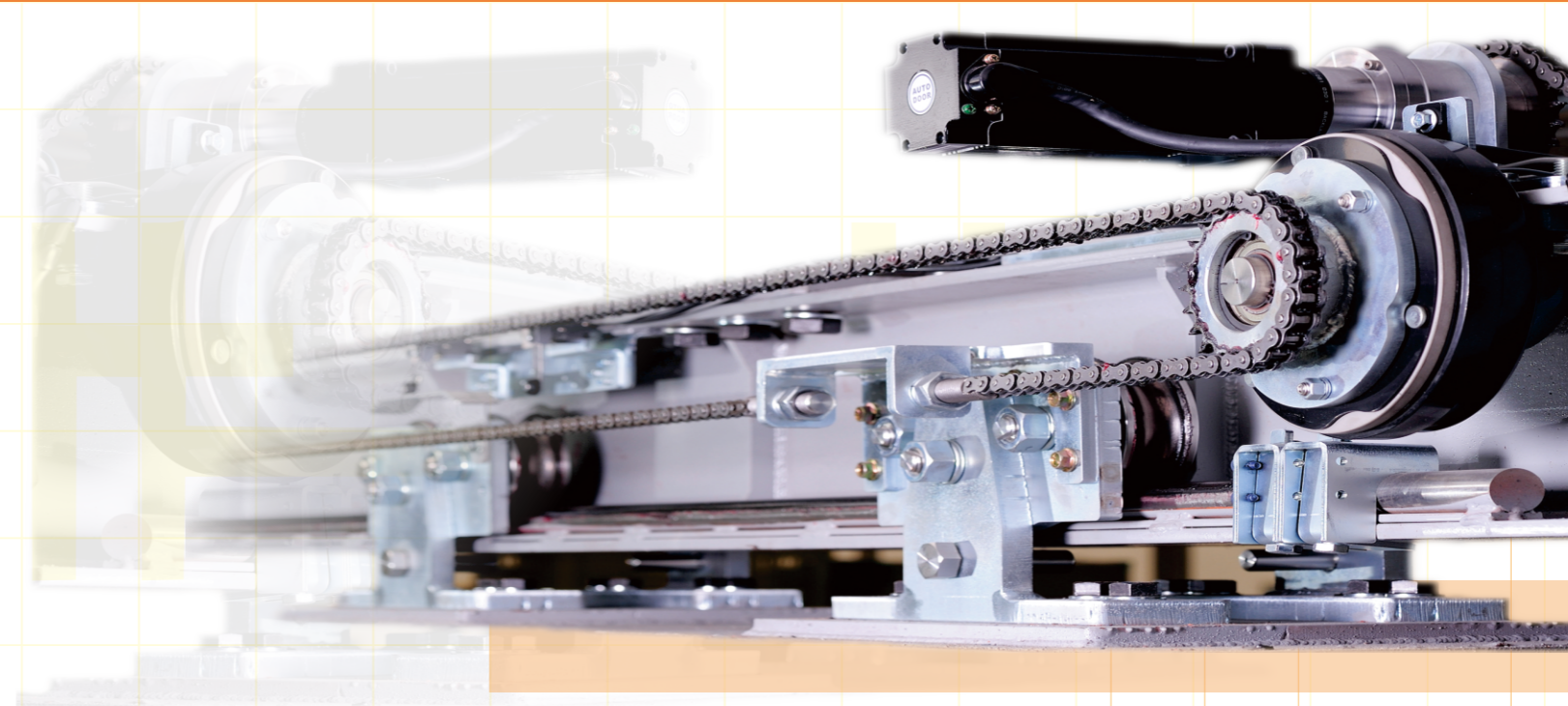

SPARE SYSTEM

MAIN SYSTEM

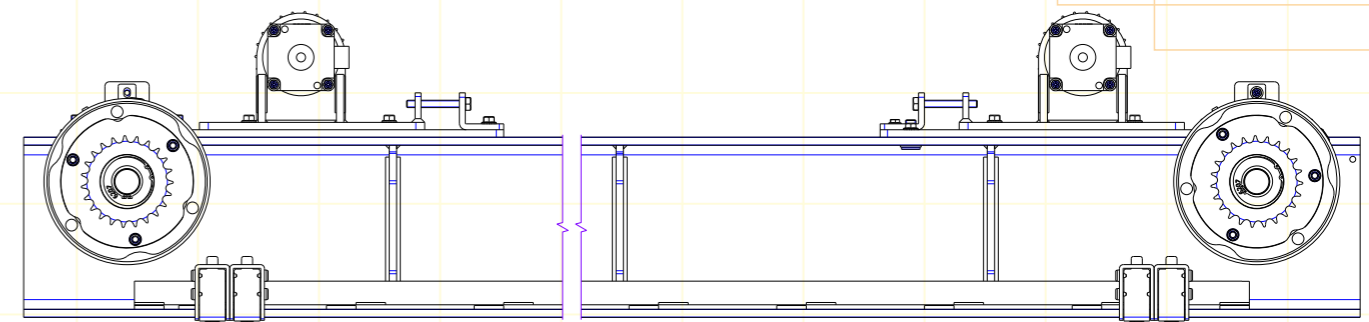

Our Operator's Features

- ★ Install in the big factories, airports, hospitals of radiation prevention door and many other large doors applications.
- ★ Second System - Equipped with the spare motor and control box to support when the main system is faulty.
- ★ Safety Function - Push "Emergency stop switch, " Door will stop immediately at any position.
- ★ Hanging Twin Wheel installs in two sides of the door panel, can balance the heavy Door weight well.