

 **KTH TH-W2 / AD-W2**
AUTOMATIC DOOR SYSTEM



■ TABLE OF CONTENTS

1. SPECIFICATION&PROFILE	1
2. SPECIFICATION&PROFILE	2
3. COMPONENTS	3
4. THE POSITION OF THE HANGING TWIN-WHEEL	4
5. INSTALL THE RACK BELT	5
6. LEGEND OF PART DRAWING	6
7. TEST & ADJUST(TH-W2)	7
8. OUTPUT CONNECT & THE ILLUSTRATION OF THE ELECTRIC LOCK CONTACT	8
9. ADJUST CONTROLLER	9
10. TEST & ADJUST(AD-W2) ADJUST CONTROLLER-1	10
11. ADJUST CONTROLLER-1.....	11
12. WIRING DIAGRAM OF TH-100	12
13. TH-125 REMOTE CONTROL TH-136 DIGITAL SWITCH	13
14. HTP-21C SAFETY BEAM & HR942D SENSOR	14
15. HR100-CT SENSOR	15
16. HR94D1-C1SENSOR	16
17. TH-201&TH-200LK LOCK	17
18. TH-135-FUNCTION KEY SWITCH	18

SPECIFICATION & PROFILE

Door thickness less than 40 mm

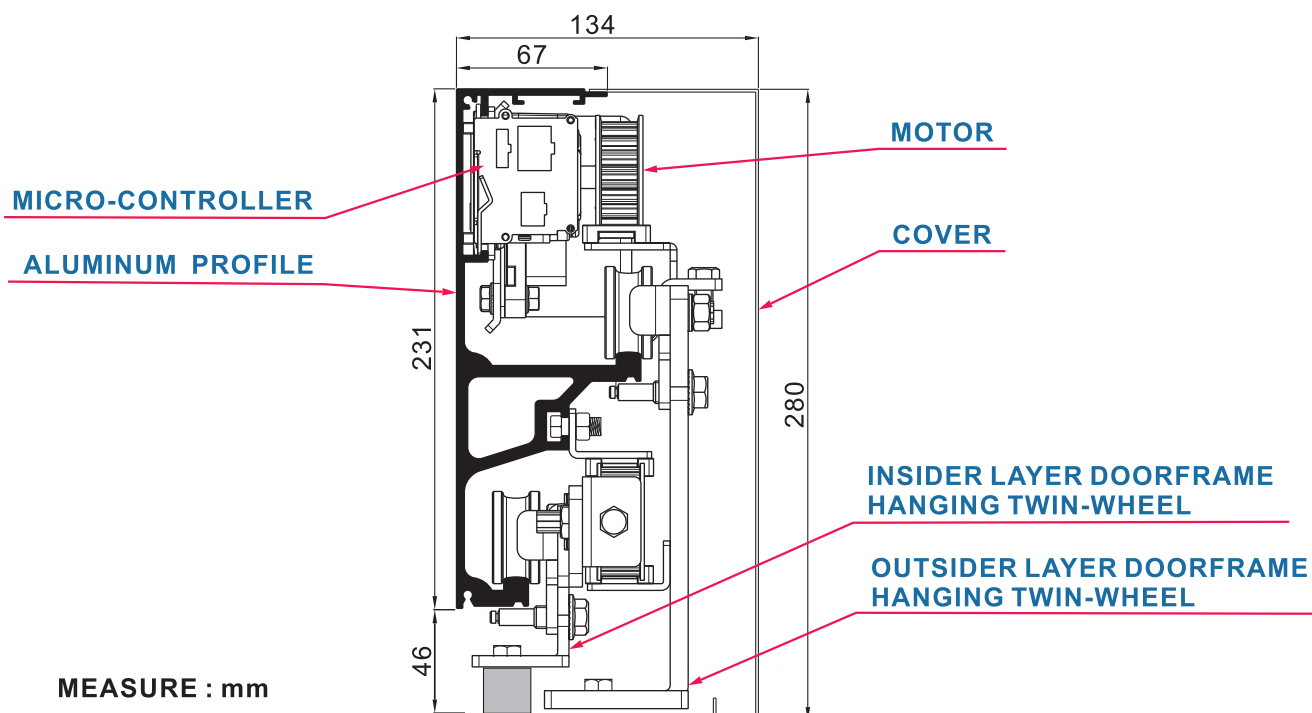

Door thickness over than 40 mm

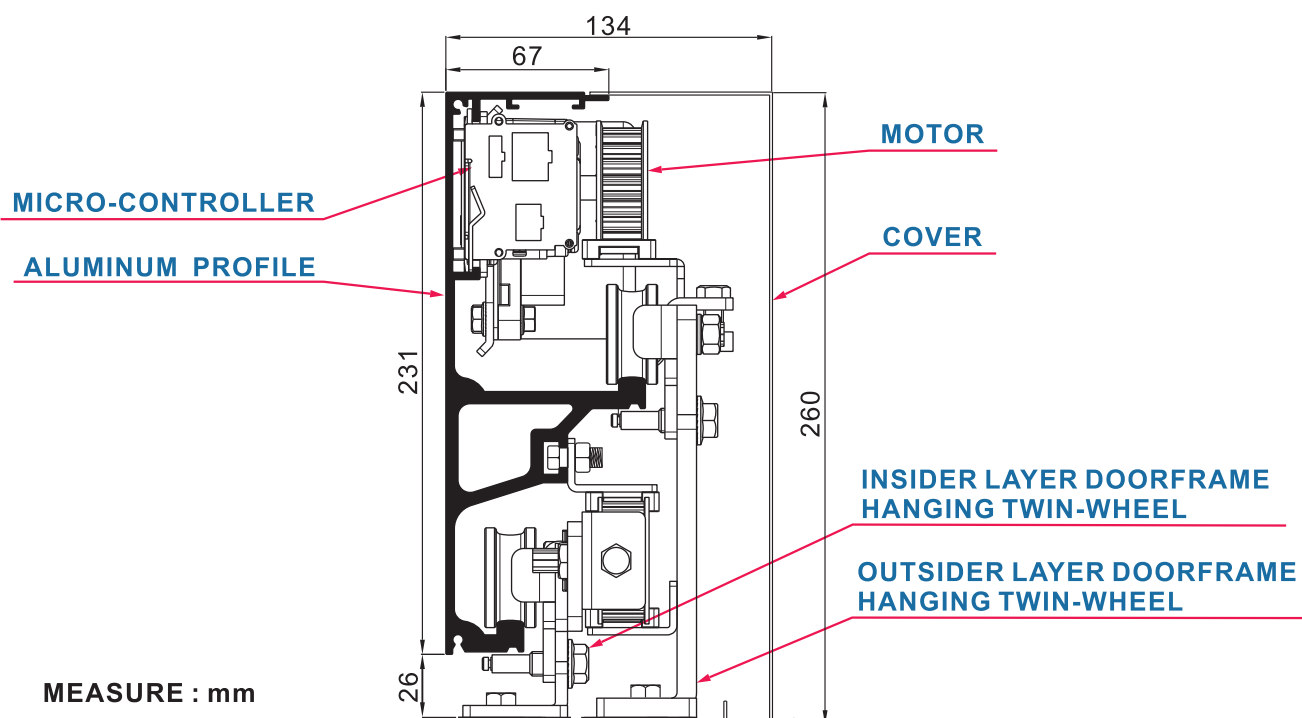

SPECIFICATION & PROFILE

TYPE	TH-W2	
MODEL	TELESCOPIC 2-WINGED	TELESCOPIC 4-WINGED
DOOR WEIGHT	130kg X2(DOOR)	90kg X4(DOOR)
DOOR WIDTH	500mm~3000mm	500mm~3000mm
INSTALL WAY	SURFACE INSTALL	SURFACE INSTALL
MOTOR	DC24V 75W BRUSHLESS DC MOTOR	
CONTROL	STANDARD MICRO-CONTROL	
POWER CONSUMPTION	75W	
VOLTAGE	AC100V~240V	
ENVIRONMENTAL TEMPERATURE	-20°C~+50°C	
VOLUME	60 DECIBEL(MAX.)	
STARTING SPEED	650mm/SEC.	600mm/SEC.
STARTING TIMES	0~20 SEC. (REGULABLE)	
TRANSMISSION IMPORTANT CONDITION	RACK BELT S8M	
OPENING DOOR RANGE	FULL/HALF-OPEN (REGULABLE)	
PFC POWER EFFICIENCY	0.95(IN AC100V FULL LOAD)	
TRACTION FORCE	3 kg	

TYPE	AD-W2	
MODEL	TELESCOPIC 2-WINGED	TELESCOPIC 4-WINGED
DOOR WEIGHT	130kg X2(DOOR)	90kg X4(DOOR)
DOOR WIDTH	500mm~3000mm	500mm~3000mm
INSTALL WAY	SURFACE INSTALL	SURFACE INSTALL
MOTOR	DC24V 75W WORM GEAR MOTOR	
CONTROL	USER-FRIENDLY MICRO-CONTROL	
POWER CONSUMPTION	75W	
VOLTAGE	AC100V~240V	
ENVIRONMENTAL TEMPERATURE	-20°C~+50°C	
VOLUME	60 DECIBEL(MAX.)	
STARTING SPEED	650mm/SEC.	600mm/SEC.
STARTING TIMES	0~20 SEC. (REGULABLE)	
TRANSMISSION IMPORTANT CONDITION	RACK BELT S8M	
OPENING DOOR RANGE	FULL/HALF-OPEN (REGULABLE)	
PFC POWER EFFICIENCY	0.95(IN AC100V FULL LOAD)	
TRACTION FORCE	3 kg	

COMPONENTS



MICRO-CONTROLLER

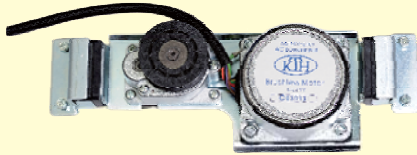

BRUSHLESS DC MOTOR



MICRO-CONTROLLER

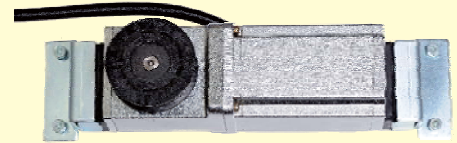

WORM GEAR MOTOR



STOPER
(2 pcs 2-winged)
(4 pcs 4-winged)



COMBINED TERMINAL BLOCK



HANGING BRACE MEDIUM
(FOR DOOR LEAF UNDER 4CM)
(2pcs 2-winged)
(4 pcs 4-winged)



Outside door-leaf HANGING TWIN-WHEEL
(1set 2-winged)
(2set 4-winged)



ACTIVE BRACE



PASSIVE BRACE



BELT BRACE



BELT FIXER-2 PCS



BELT ROLLER



Inside door-leaf HANGING TWIN-WHEEL(left side)
Only for 4-winged



Inside door-leaf HANGING TWIN-WHEEL(right side)



SENSORS
(OPTIONAL DEVICE)



WIRE CLAMP-5 PCS



Hanging Brace
(4pcs 2-winged)
(8pcs 4-winged)



RACK BELT

THE POSITION OF THE HANGING TWIN-WHEEL

TELESCOPIC 2-WINGED SLIDING DOORS

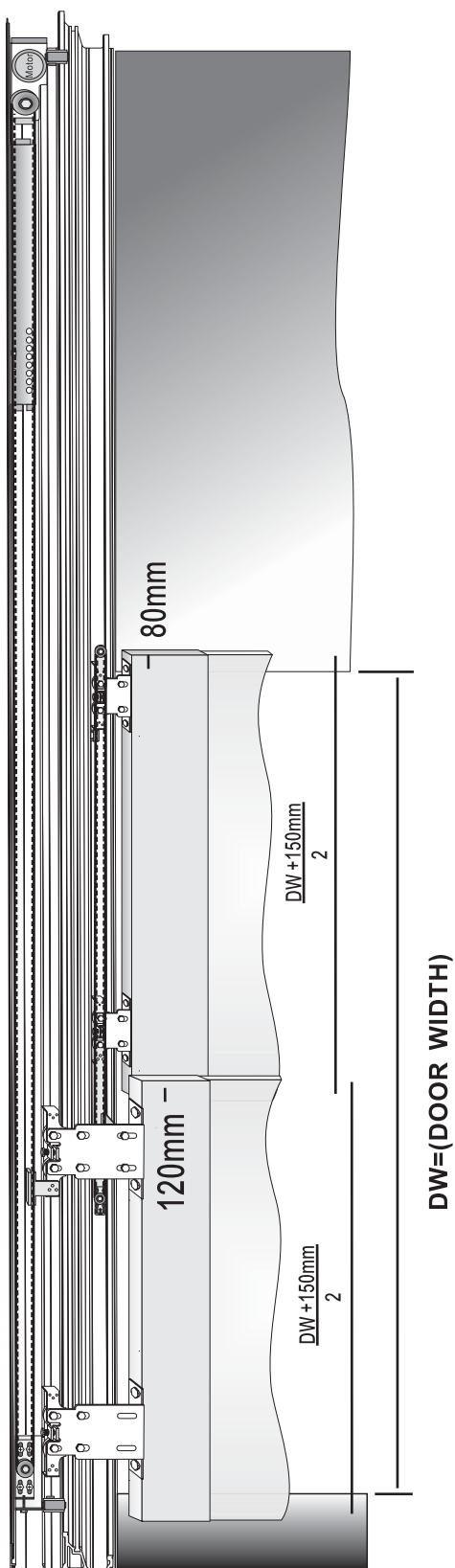

TELESCOPIC 4-WINGED SLIDING DOORS

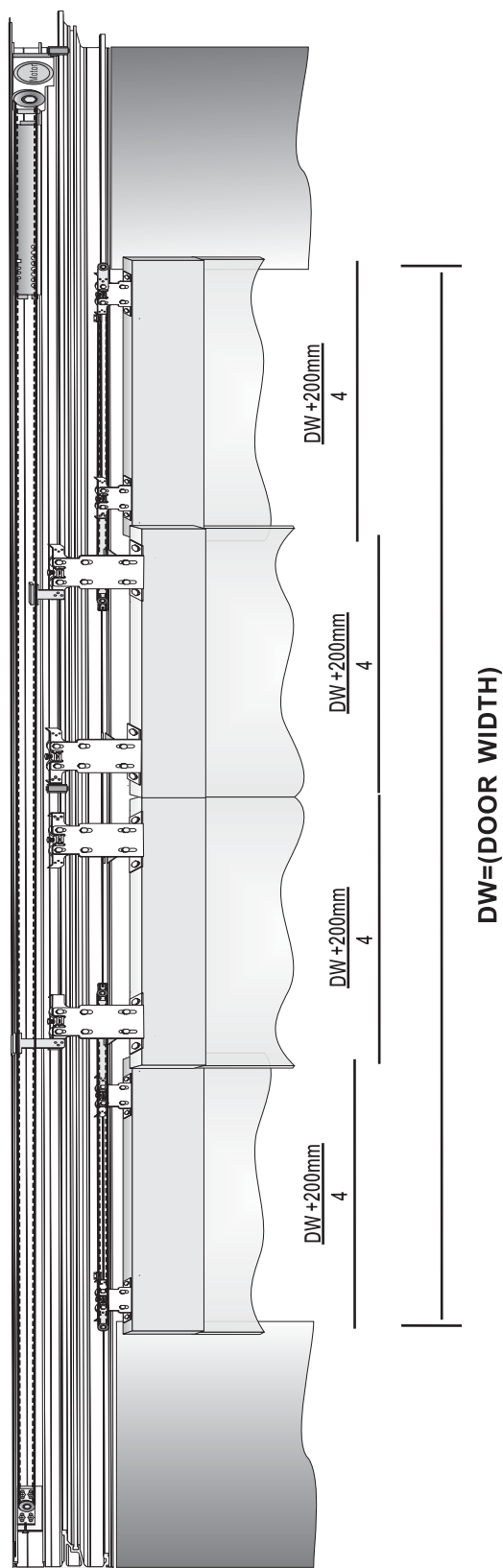

INSTALL THE RACK BELT

TELESCOPIC 2-WINGED SLIDING DOORS

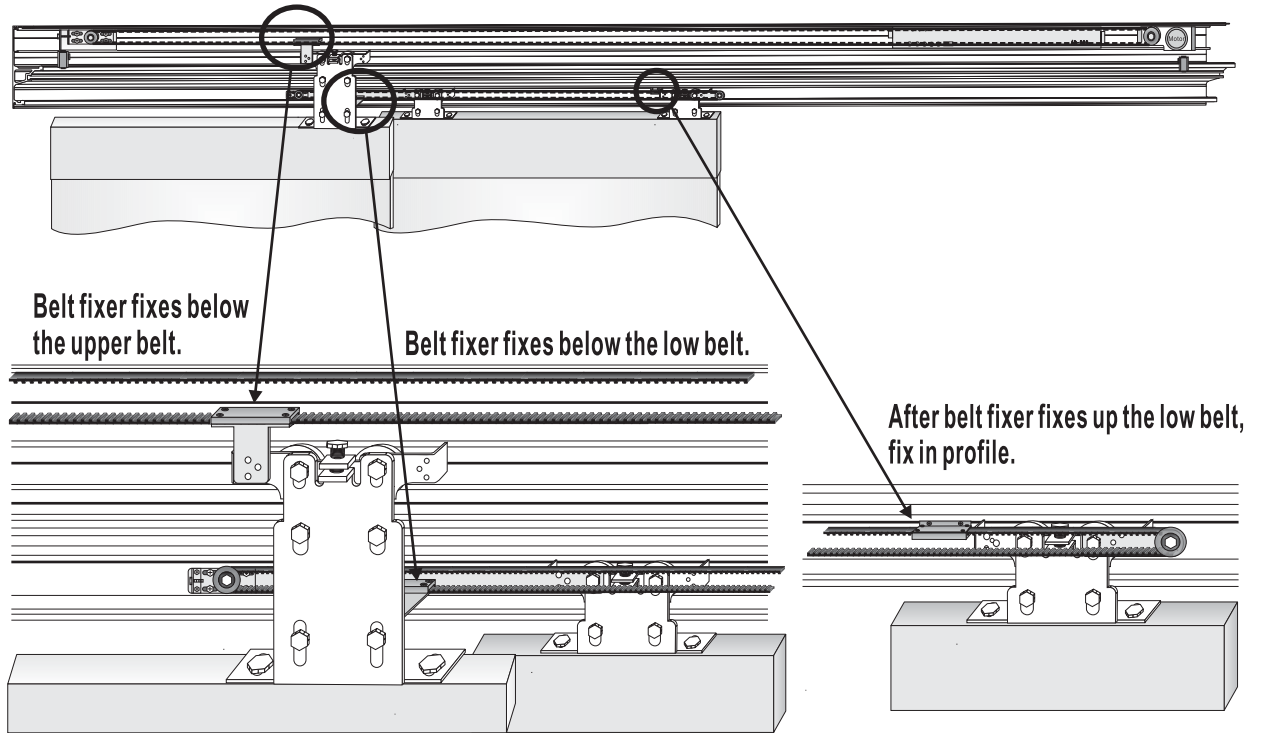

TELESCOPIC 4-WINGED SLIDING DOORS

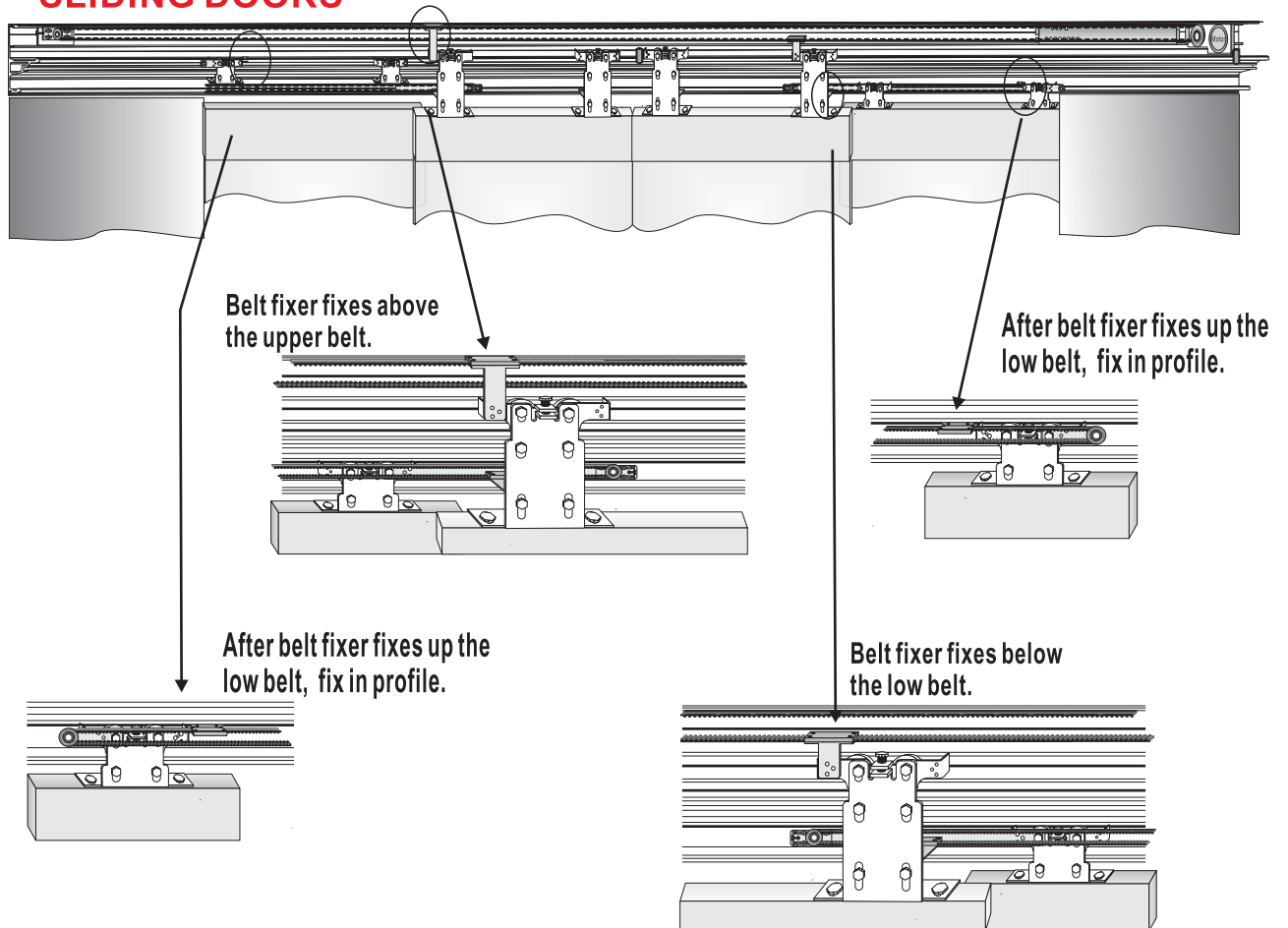

LEGEND OF PART DRAWING

Parts List		
No.	Parts Name	Quantity
1	Aluminum profile	1
2	Motor	1
3	Controller	1
4	Belt roller	1
5	Outside door-leaf hanging twin-wheel	2
6	Inside door-leaf hanging twin-wheel	2
7	Belt fixer	2
8	Rack belt	1
9	Stopper	2
10	Power switch	1

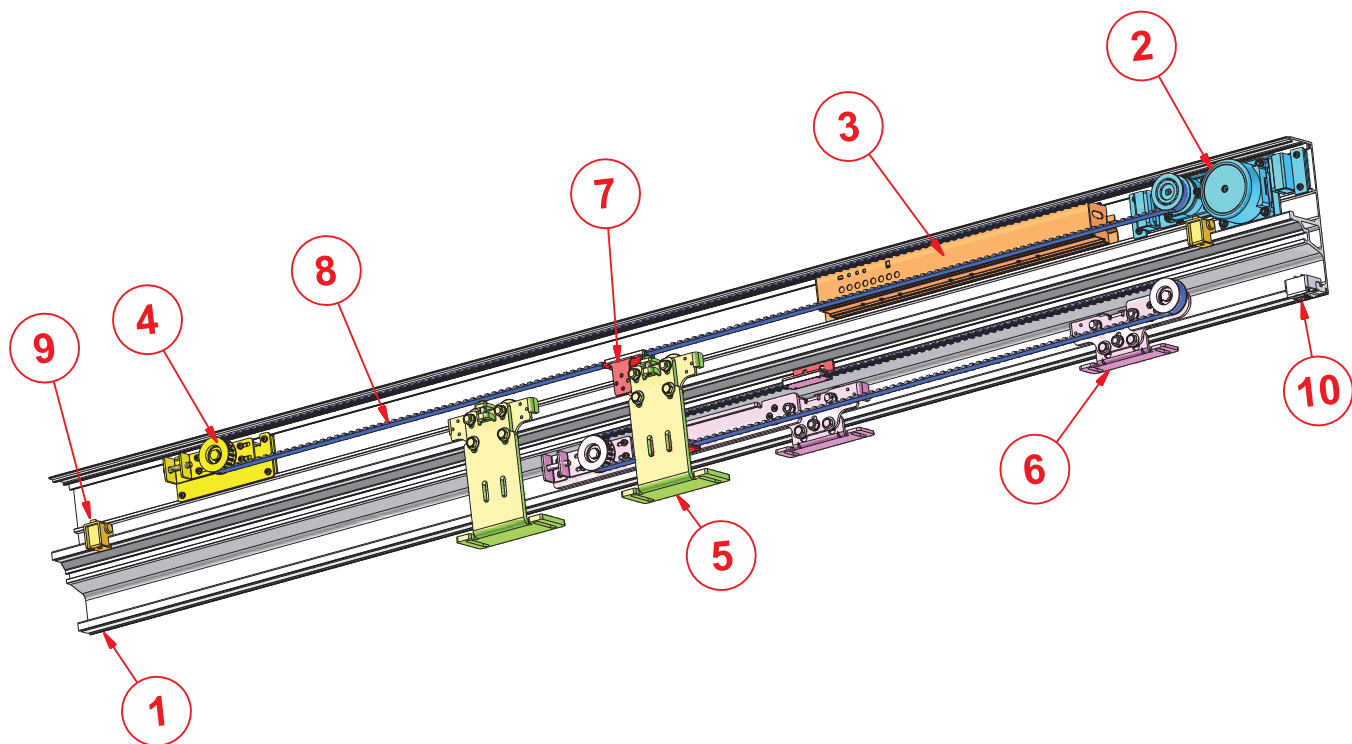

TEST & ADJUST (TH-W2)

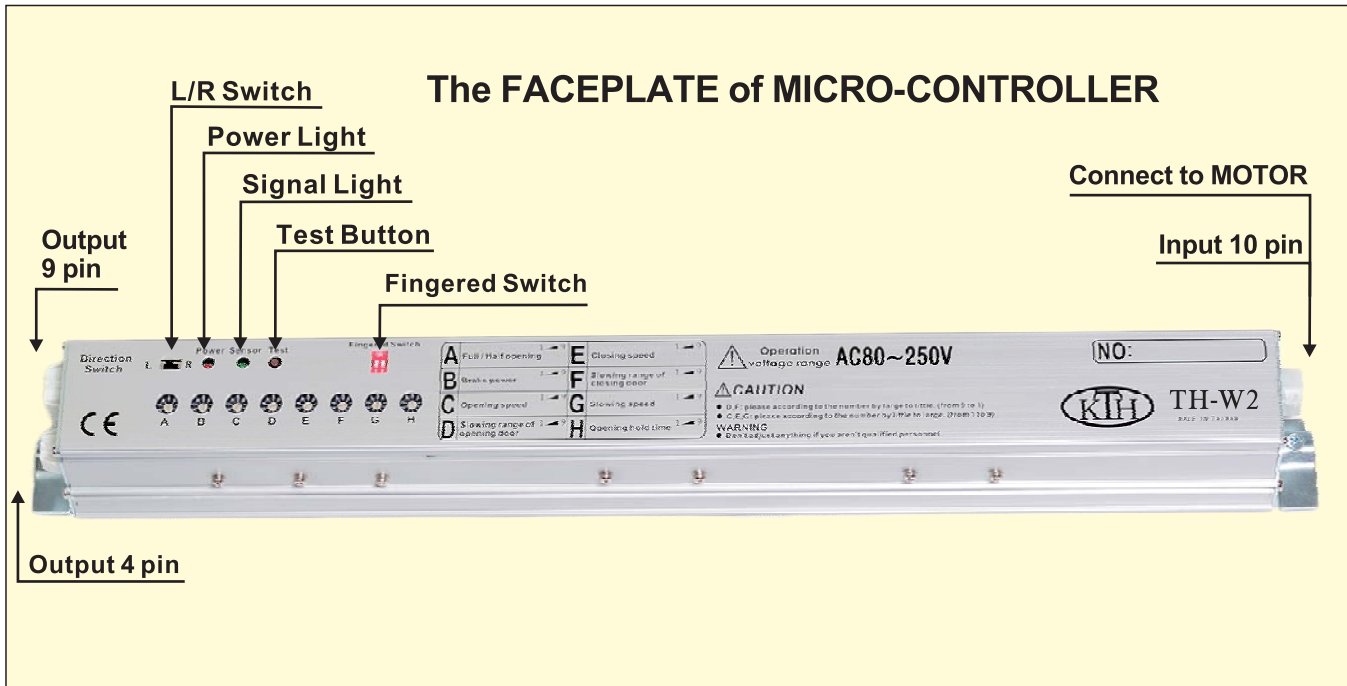

Red LED-Power is connected.

Green LED-Input the open door signal.

L/R switch-The direction of the door opening: right/left(R/L).

Fingered Switch- Pin 1- Directional Function

Operation $\left\{ \begin{array}{l} \text{OFF: Normal mode.} \\ \text{ON: push once, open the door. Push again, close} \\ \text{the door.} \end{array} \right.$

Fingered Switch- Pin 2- Reverse Switch: in order to control opening and closing direction of the Door
-Leaf after power resumes.

Operation $\left\{ \begin{array}{l} \text{OFF: Normal mode, after power resumes, the Door-Leaf} \\ \text{opens the door first.} \\ \text{ON: suitable for Security System, after power resumes,} \\ \text{the Door-Leaf closes the door first.} \end{array} \right.$

OUTPUT CONNECT

MICRO-CONTROLLER

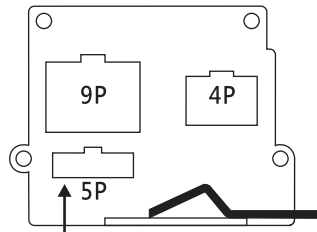

Connect to Terminal Block

- Red** DC13V ⊕ — Output DC13V 1A for ELECTRIC LOCK use
- Black** GND ⊖ —
- Blue** — Output NC signal
- Green** —
- Orange** — ELECTRIC LOCK enable
- Yellow** —
- Gray** — Full/Half opening signal
- Purple** —

- Red** DC24V ⊕ — Power of SENSOR
- Black** GND ⊖ —
- Orange** — The signal of SENSOR
- Orange** —

PS : 5P terminal is required using with Combined Terminal Block.

OUTPUT CONNECT

9P terminal

Black	Red	Orange
Yellow	Green	Blue
Purple	Gray	

4P terminal





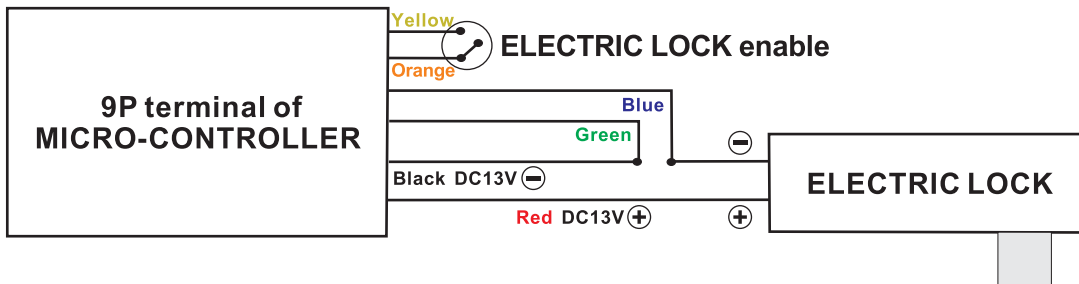



Black	Red
Orange	Orange

THE ILLUSTRATION OF THE ELECTRIC LOCK CONTACT



PS: After the orange and the yellow lines are short circuit, the blue and the green lines would output NC signal.

ADJUST CONTROLLER

-  **A Full/Half opening**
Adjust the RANGE of the HALF OPEN DISTANCE.
Higher number, wider range.
-  **B Brake power**
The Door-Leaf is slight, the BRAKE POWER is less.
Please choose 0~2 if the Door-Leaf is under 50kg.
Please adjust number from number 5 if the Door-Leaf is over 80kg.
-  **C The opening speed of the door**
Adjust the OPEN SPEED.
Higher number, faster speed.
CAUTION: please adjust the number one by one from low to high.
-  **D The slowing range of opening door**
Adjust the SLOW RANGE of OPENING DOOR
Higher number, more range about the slow range at open door position.
CAUTION: please adjust the number one by one from high to low.
-  **E The closing speed of the door**
Adjust the CLOSED SPEED. Higher number, faster speed.
CAUTION: please adjust the number one by one from low to high.
-  **F The slowing range of closing door**
Adjust the SLOW RANGE of CLOSED DOOR
Higher number, more range about the slow range at open door position.
CAUTION: please adjust the number one by one from high to low.
-  **G The slowing speed of the door**
Adjust the SLOW SPEED. Higher number, faster speed.
CAUTION: please adjust the number one by one from low to high.
-  **H Opening hold time**
Adjust the HOLD OPEN TIME.
Higher number, the hold time is longer.

NUMBER	0	1	2	3	4	5	6	7	8	9
SECOND	0	1	2	3	4	5	6	10	15	20

■ TEST & ADJUST(AD-W2)

The FACEPLATE of MICRO-CONTROLLER

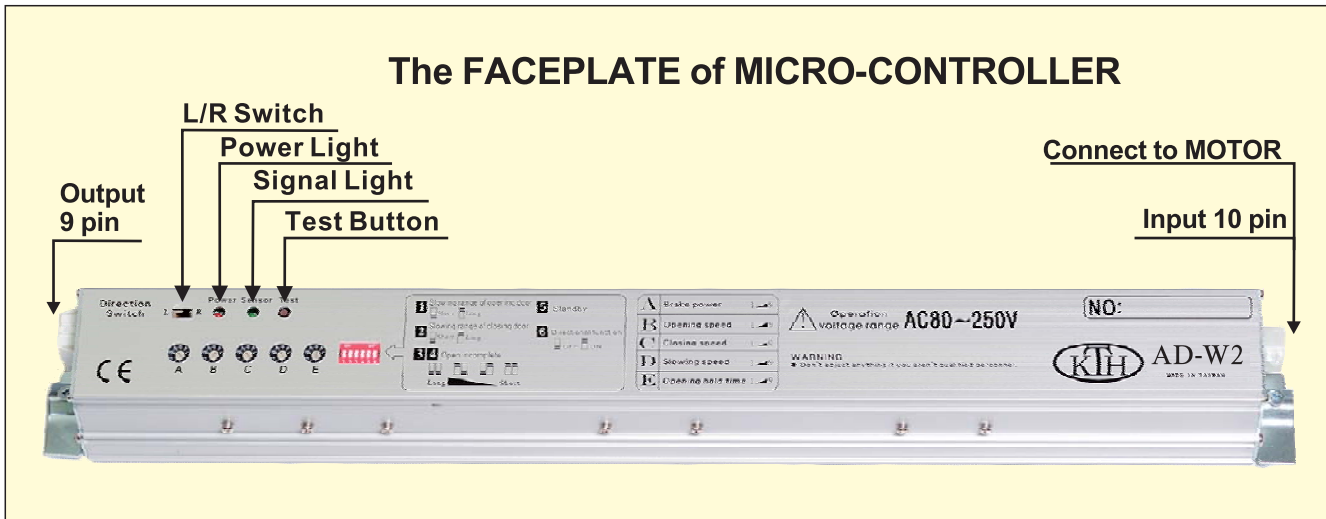

Red LED-Power is connected.

Green LED-Input the open door signal.

L/R switch-The direction of the door opening: right/lift(R/L).

■ ADJUST CONTROLLER-1



A Brake power

The Door-Leaf is slight, the BRAKE POWER is less.

Please choose 0~2 if the Door-Leaf is under 50kg.

Please adjust number from number 5 if the Door-Leaf is over 80kg.



B The opening speed of the door

Adjust the OPEN SPEED. Higher number, faster speed.

CAUTION: please adjust the number one by one from low to high.

■ ADJUST CONTROLLER-1



C The closing speed of the door

Adjust the CLOSED SPEED. Higher number, faster speed.
CAUTION: please adjust the number one by one from low to high.



D The slowing speed of the door

Adjust the SLOW SPEED. Higher number, faster speed.
CAUTION: please adjust the number one by one from low to high.



E Opening hold time

Adjust the HOLD OPEN TIME. Higher number, the hold time is longer.

NUMBER	0	1	2	3	4	5	6	7	8	9
SECOND	0	1	2	3	4	5	6	10	15	20

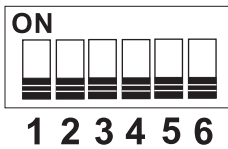

Fingered Switch

1 Slowing range of opening door



5 Reverse Switch: in order to control opening and closing direction of the Door-Leaf after power resumes.



2 Slowing range of closing door



Operation → OFF: Normal mode, after power resumes, the Door-Leaf opens the door first.
 → ON: suitable for Security System, after power resumes, the Door-Leaf closes the door first.

3 4 Open incomplete



6 Directional function



Operation → OFF: Normal mode.
 → ON: push once, open the door. Push again, close the door.

WIRING DIAGRAM OF TH-100(STANDARD)

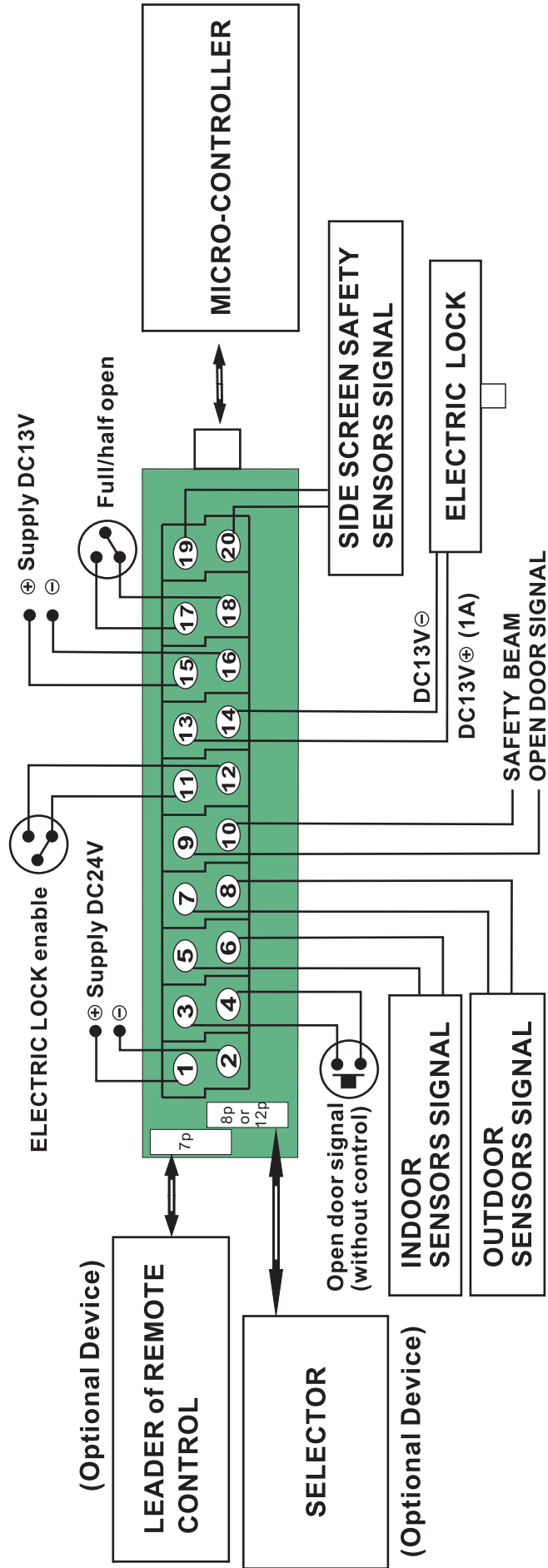

■ TH-125 (NEW)-REMOTE CONTROL

1. Transmitter is 20 bit digital code that is much safety and use fix-frequency component to transmit signal. The frequency of transmitter won't be affected by battery consumption and outside environment.
2. Wireless receiver use super-heterodyne from U.S.A..
The receiver is stably, anti-interference, no extra-wave.
3. Control unit is 8 bit single chip. The order is accurate and action is correct.

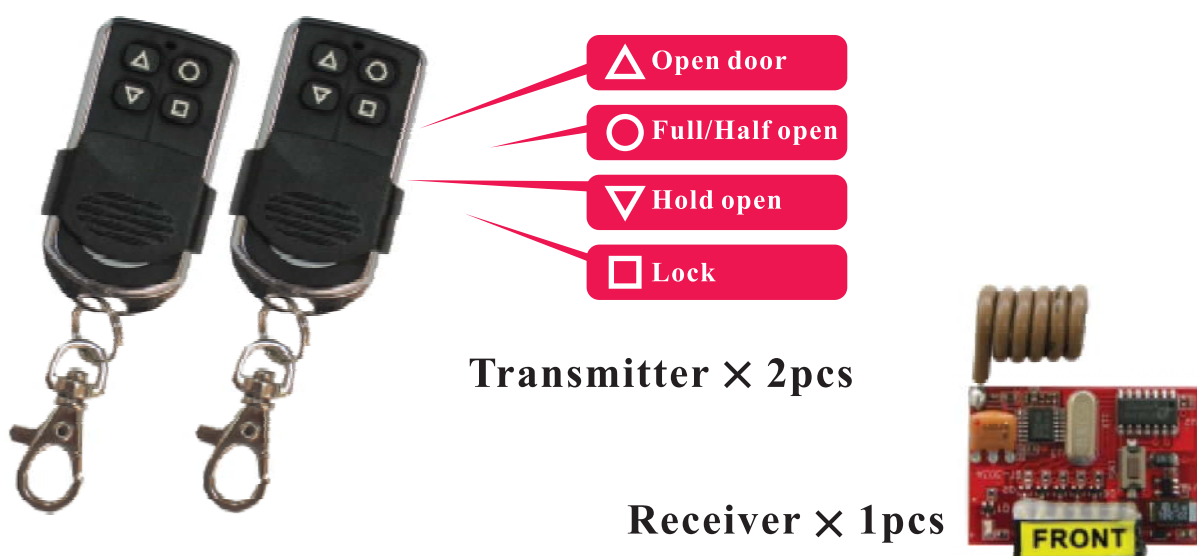

■ TH-136-MULTIFUNCTION DIGITAL SWITCH

1. Particular Memory Mode according different sessions to work.
2. Safety Alarm by itself to avoid danger happening.
3. Optional Language for easier operate in your location
4. Date and Time setting
5. Easy to install and program.
6. Beautiful and clear LCD panel
7. With buttons lock-on function

VOLUME	124.5X80X38.5(mm)
NET WEIGHT	0.46kg
ACCESSORIES	One piece of 5M cable



■ HTP-21C-SAFETY BEAM(HOTRON)

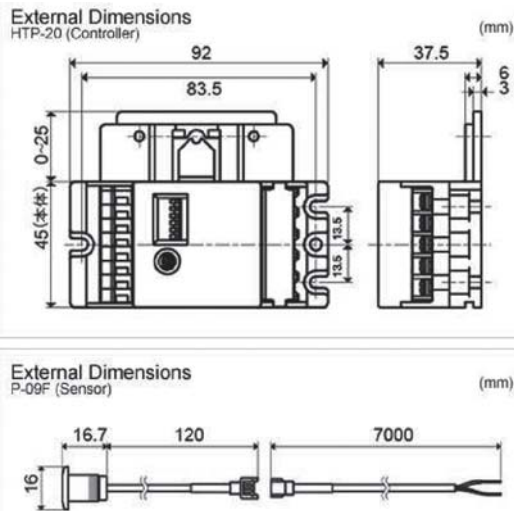

1. Beam sensor consisting of a controller and a single or dual set of infrared beams.
2. No need to use tools for wiring connection with compact controller.
3. Available to select penetration set-up or direct reflection set-up by setting switch.
4. Blink (under penetration setting), ON or OFF of LED tells you about the most suitable setting of volume adjustment by microcomputer control.

■ HR942D-INFRARED RAY SENSOR



1. The sensor body can be angled at up to 10° to ensure timely detection of fast moving traffic.
2. Presence timer settings adjustable to 2, 15 60 and 180 seconds.
3. The sensor microprocessor automatically takes countermeasures against adverse conditions such as falling snow and strong sunrays and electrical noise.
4. Quick installation and easy to adjust.
5. Active area is very specific with high degree of adjustment flexibility.
6. 12-24V AC-DC operations, Normal Open relay.
7. Simple design to suit with every Automatic Door.

■ HR100-CT-ACTIVATION+MONITORED SAFETY(HOTRON)

Advanced Unidirectional Detection Sensor with Monitored Safety and Unique "Door Learn" Ability



Pioneering super sensor offers pedestrian door activation and unprecedented safety at mounting heights of up to 3m

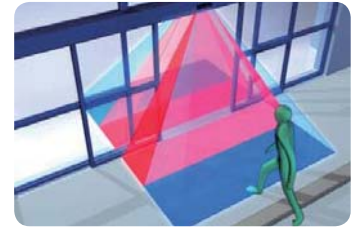
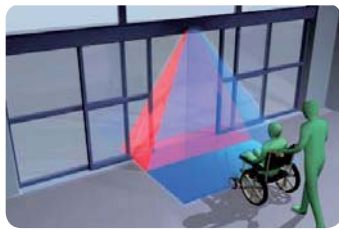

- **Energy Efficient**

Intelligent unidirectional detection ability reduces door hold open time by 20% and building energy loss by 6% in a standard installation.

- **Unparalleled Pedestrian Safety**

Unique ability to memorize door motion allows the infrared safety unparalleled pedestrian safety.

- **Versatile**

Flexibility to adjust the door activation and pedestrian safety detection zones independently makes the HR100-CT the ideal **sensor for every** sliding door installation

- **Ease of Installation**

All the information necessary to install the HR100-CT sensor is printed on the sensor body

■ HR94D1-C1- MONITORED SAFETY(HOTRON)

Monitored Sliding Door Side Screen or Door Threshold Pedestrian Safety Sensor.



ACCESSORY FOR EN16005 OPERATORS



Versatile and simple to set up, the HR94D1-C1 protects pedestrians from the dangers of both opening and closing sliding doors at mounting heights of up to 3m

- Sliding Door Side Screen Pedestrian Safety**
 Protect pedestrians from the dangerous leading door edge during door open cycles with a dense curtain of infrared safety
- Door Threshold Pedestrian Safety**
 Safeguard pedestrians from hazardous door closures due to a shallow but wide infrared safety curtain that is monitored once per door cycle
- Solid & Reliable**
 Avoid the risk of loss or damage to individual sensor parts through a one piece sensor body construction
- Simple to Install**
 Install with ease without the need for a remote control thanks to comprehensive instructions printed on the sensor body

TH-201-MEGNETIC LOCKS

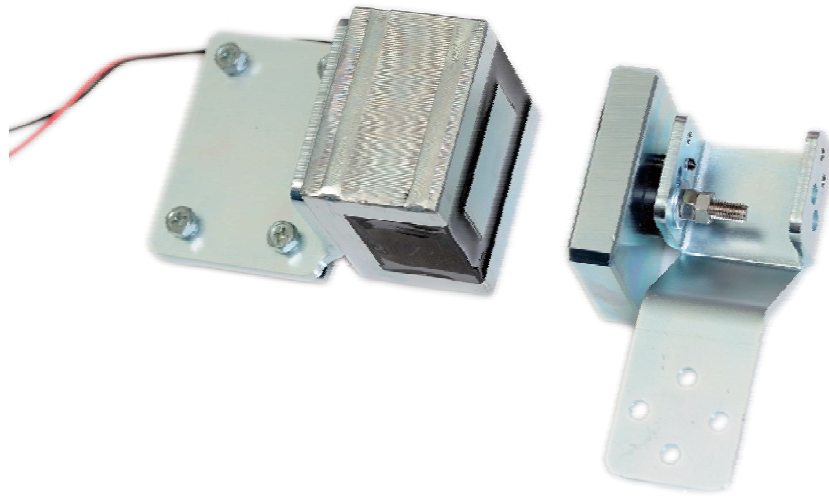

1. Main subject molded integrally and it can simplify installation procedures
2. Use aluminum alloy frame, strong crashworthy
3. Compact size, it can follow the installation (door type, sliding type)

TH-200LK-ELECTRIC BOLT



1. Don't increase the temperature while it running and working.
2. Tough and durable. There is no problems about the lock be lodged.

■ TH-135-FUNCTION KEY SWITCH



1. It's suitable any Door Operator of KTH.
2. Easy to install and adjust.

● SIX PRESS FUNCTION

- | | |
|---------------|----------------|
| 1. DOOR OPEN | 2. IN ONE-WAY |
| 3. AUTO | 4. OUT ONE-WAY |
| 5. DOOR CLOSE | 6. FULL/HALF |

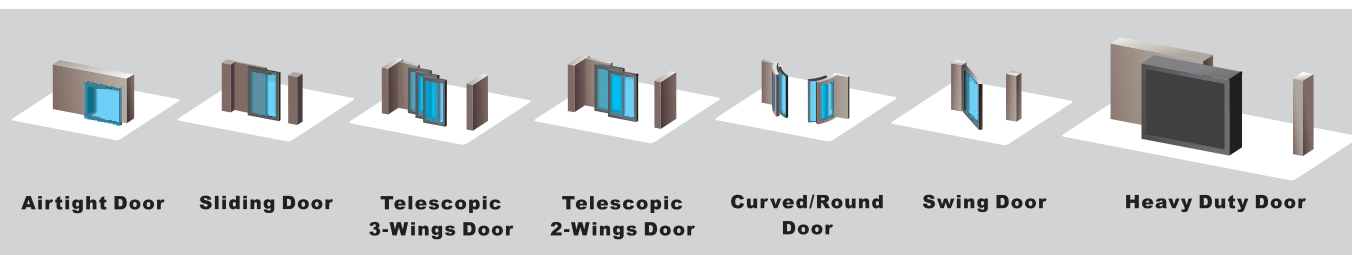

 KING TA HAN TECHNOLOGY CO., LTD

TEL:+886-7-8413699

FAX:+886-7-8413711

ADD:(80673) 2F-1,#286-8,Sinya Rd., Cianjhen District, Kaohsiung City, Taiwan